

# CONTENTS

**SEMICONDUCTOR SHAPES** ..... 2-2

**BLOCK DIAGRAM** ..... 2-3

**CIRCUIT DIAGRAMS**

**MAIN PWB CIRCUIT DIAGRAM** ..... 2-5

**POWER & DEF PWB CIRCUIT DIAGRAM** ..... 2-9

**100Hz PWB CIRCUIT DIAGRAM** ..... 2-11

**MICON PWB CIRCUIT DIAGRAM** ..... 2-13

**FRONT CONTROL PWB CIRCUIT DIAGRAM** ..... 2-15

**CRT SOCKET PWB CIRCUIT DIAGRAM** ..... 2-17

**AV SW PWB CIRCUIT DIAGRAM** ..... 2-19

**SYNC SEP PWB CIRCUIT DIAGRAM** ..... 2-21

**BLK SEP PWB CIRCUIT DIAGRAM** ..... 2-22

**PATTERN DIAGRAMS**

**MAIN PWB PATTERN** ..... 2-23

**POWER & DEF PWB PATTERN** ..... 2-25

**100Hz PWB PATTERN** ..... 2-27

**MICON PWB PATTERN** ..... 2-29

**CRT SOCKET PWB PATTERN** ..... 2-31

**AV SW PWB PATTERN** ..... 2-32

**FRONT CONTROL PWB PATTERN** ..... 2-33

**SYNC SEP PWB PATTERN** ..... 2-33

**BLK PWB PATTERN** ..... 2-34

## SEMICONDUCTOR SHAPES

### TRANSISTOR

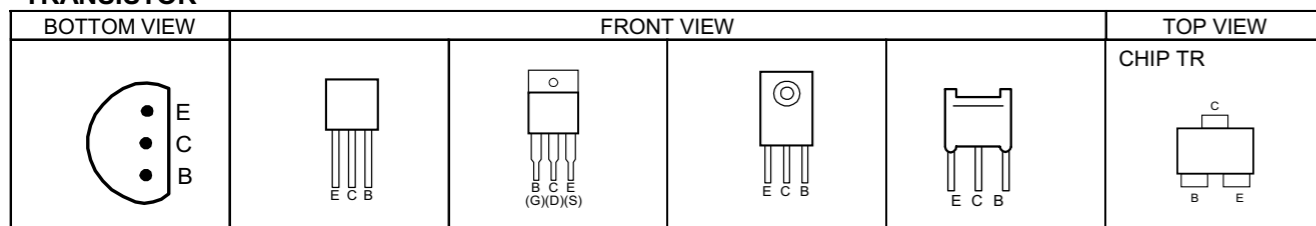

### IC

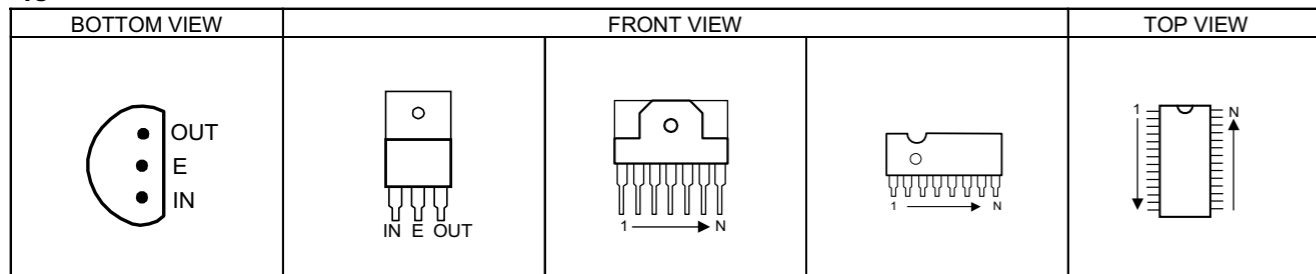

### CHIP IC

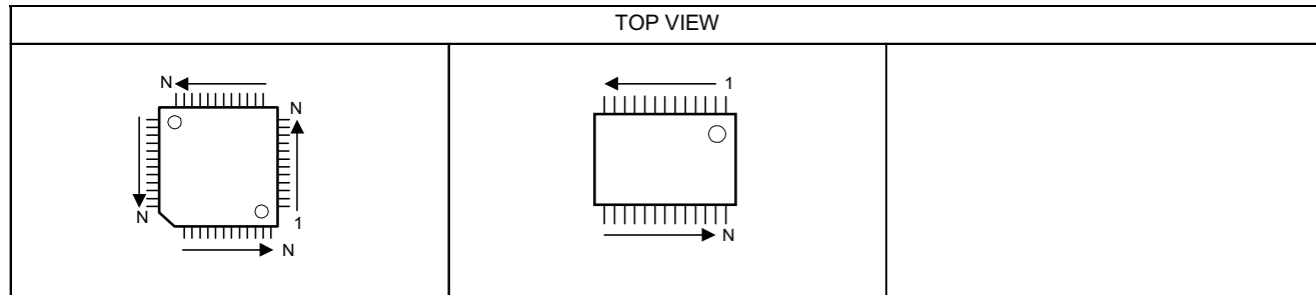

# STANDARD CIRCUIT DIAGRAM

## NOTE ON USING CIRCUIT DIAGRAMS

### 1.SAFETY

The components identified by the  $\Delta$  symbol and shading are critical for safety. For continued safety replace safety critical components only with manufactures recommended parts.

### 2.SPECIFIED VOLTAGE AND WAVEFORM VALUES

The voltage and waveform values have been measured under the following conditions.

- (1)Input signal : Colour bar signal
  - (2)Setting positions of each knob/button and variable resistor :Original setting position when shipped
  - (3)Internal resistance of tester :DC 20k  $\Omega$ /V
  - (4)Oscilloscope sweeping time :H  $\Rightarrow$  20 $\mu$ S/div  
:V  $\Rightarrow$  5mS/div  
:Others  $\Rightarrow$  Sweeping time is specified
  - (5)Voltage values :All DC voltage values
- \* Since the voltage values of signal circuit vary to some extent according to adjustments, use them as reference values.

### 3.INDICATION OF PARTS SYMBOL [EXAMPLE]

- In the PW board :R1209 $\rightarrow$ R209

### 4.INDICATIONS ON THE CIRCUIT DIAGRAM

#### (1)Resistors

- Resistance value
    - No unit :[ $\Omega$ ]
    - K :[K  $\Omega$ ]
    - M :[M  $\Omega$ ]
  - Rated allowable power
    - No indication :1/10 [W]
    - Others :As specified
  - Type
    - No indication :Carbon resistor
    - OMR :Oxide metal film resistor
    - MFR :Metal film resistor
    - MPR :Metal plate resistor
    - UNFR :Uninflamable resistor
    - FR :Fusible resistor
- \*Composition resistor 1/2 [W] is specified as 1/2S or Comp.

#### (2)Capacitors

- Capacitance value
    - 1 or higher :[pF]
    - less than 1 :[ $\mu$ F]
  - Withstand voltage
    - No indication :DC50[V]
    - Others :DC withstand voltage [V]
    - AC indicated :AC withstand voltage [V]
- \*Electrolytic Capacitors  
47/50[Example]:Capacitance value [ $\mu$ F]/withstand voltage[V]

- Type
  - No indication :Ceramic capacitor
  - MY :Mylar capacitor
  - MM :Metalized mylar capacitor
  - PP :Polypropylene capacitor
  - MPP :Metalized polypropylene capacitor
  - MF :Metalized film capacitor
  - TF :Thin film capacitor
  - BP :Bipolar electrolytic capacitor
  - TAN :Tantalum capacitor

#### (3)Coils

- No unit :[ $\mu$ H]
- Others :As specified

#### (4)Power Supply

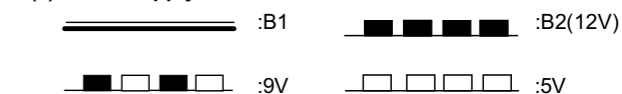

\*Respective voltage values are indicated

#### (5)Test point

- :Test point
- :Only test point display

#### (6)Connecting method

- :Connector
- :Wrapping or soldering
- :Receptacle

#### (7)Ground symbol

- :LIVE side ground
- :ISOLATED(NEUTRAL) side ground
- :EARTH ground
- :DIGITAL ground

## 5.NOTE FOR REPAIRING SERVICE

This model's power circuit is partly different in the GND. The difference of the GND is shown by the LIVE : ( $\perp$ ) side GND and the ISOLATED(NEUTRAL) : ( $\neq$ ) side GND. Therefore, care must be taken for the following points.

- (1)Do not touch the LIVE side GND or the LIVE side GND and the ISOLATED(NEUTRAL) side GND simultaneously. If the above caution is not respected, an electric shock may be caused. Therefore, make sure that the power cord is surely removed from the receptacle when, for example, the chassis is pulled out.
- (2)Do not short between the LIVE side GND and ISOLATED(NEUTRAL) side GND or never measure with a measuring apparatus ( oscilloscope, etc.) the LIVE side GND and ISOLATED(NEUTRAL) side GND at the same time. If the above precaution is not respected , a fuse or any parts will be broken.

◇ Since the circuit diagram is a standard one, the circuit and circuit constants may be subject to change for improvement without any notice.

#### ◇ NOTE

Due improvement in performance, some part numbers show in the circuit diagram may not agree with those indicated in the part list.

When ordering parts, please use the numbers that appear in the Parts List.

# BLOCK DIAGRAM

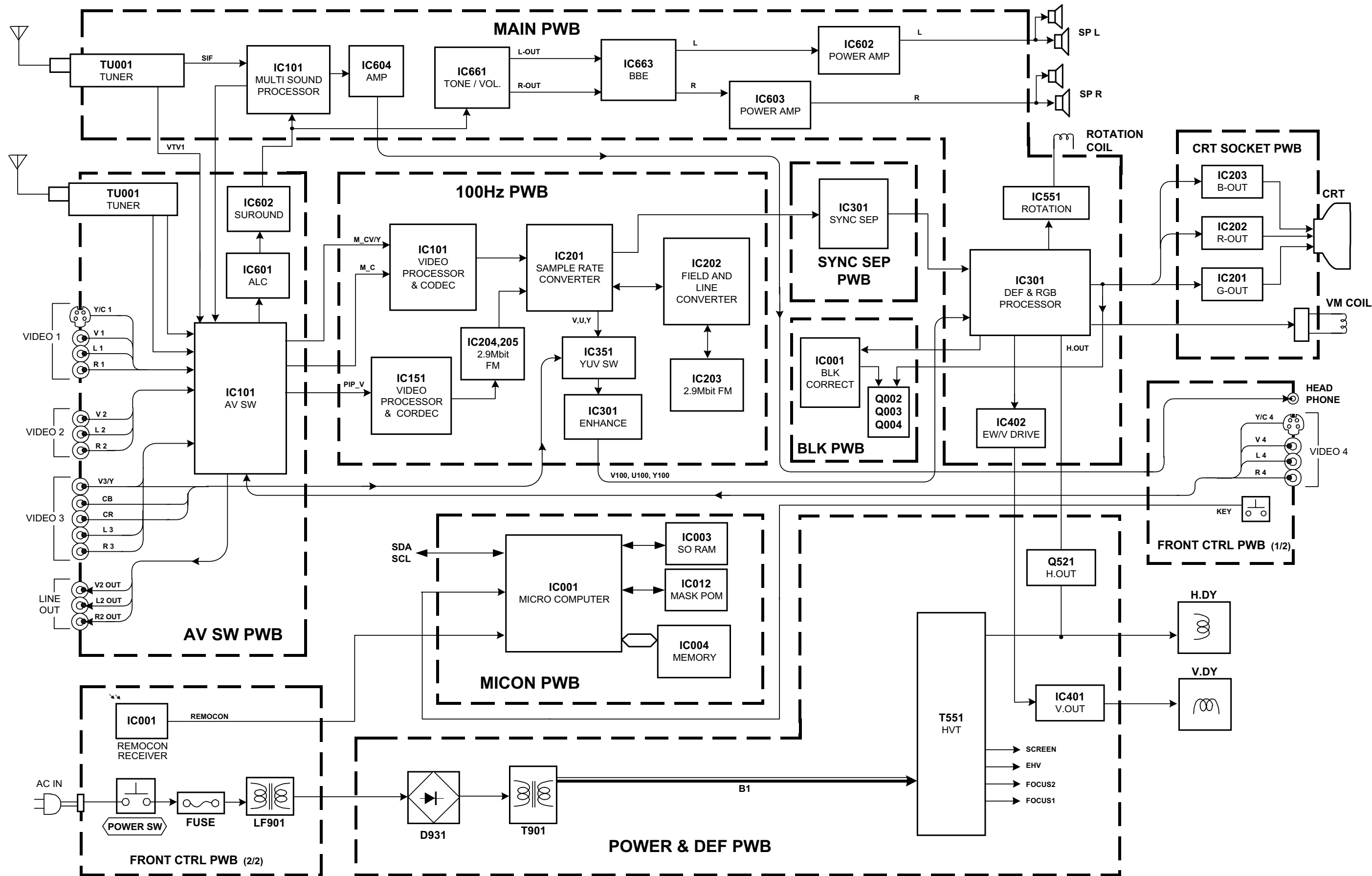

CIRCUIT DIAGRAMS MAIN PWB CIRCUIT DIAGRAM

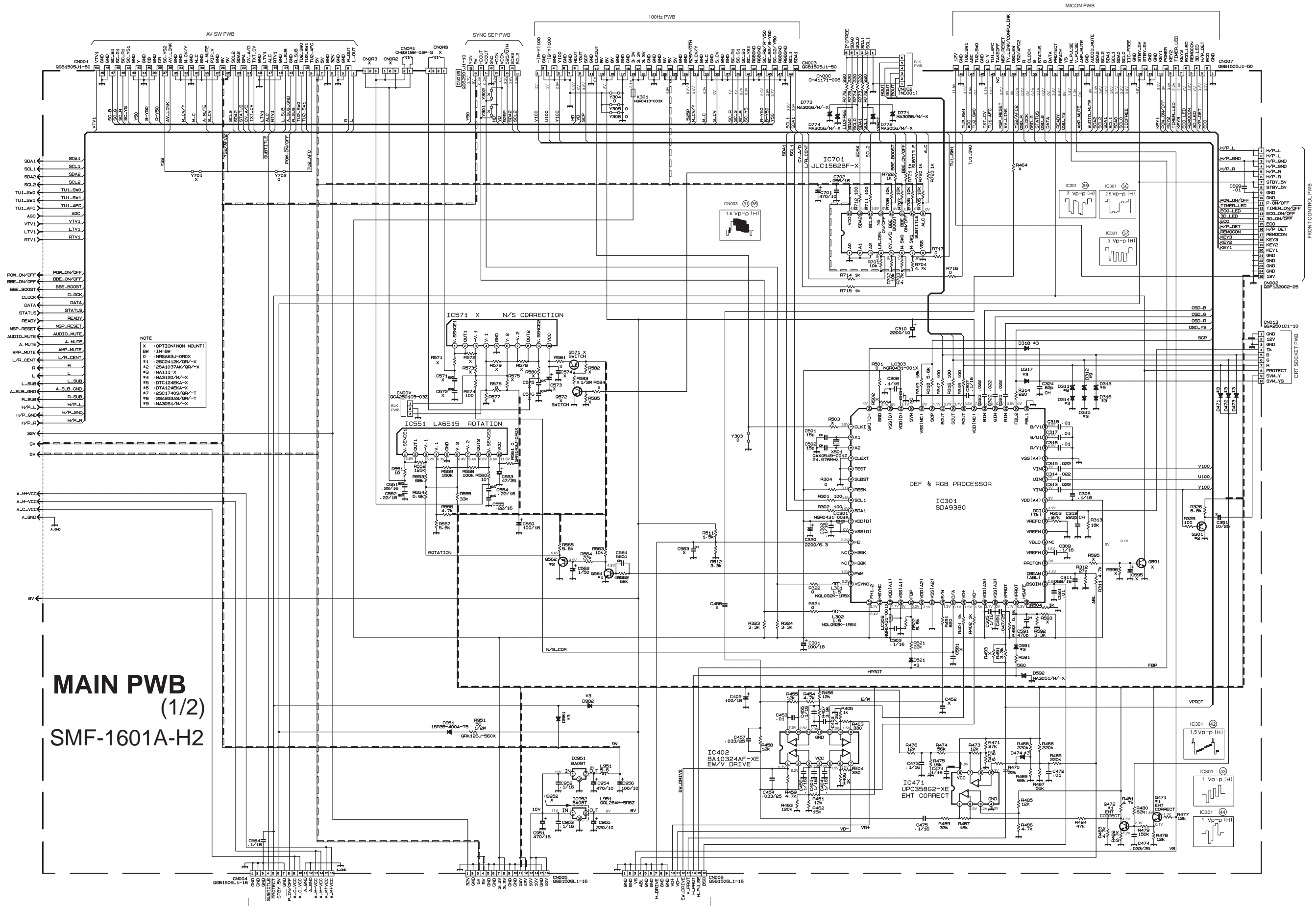

NOTE

- X -OPTION(NON MOUNT)
- BW 12H-BW
- O NFR6453-QR0X
- #1 25C2412K/GR-V-X
- #2 25A1037AK/GR-V-X
- #3 MA1111-X
- #4 MA3120/W-X
- #5 DTC124EKA-X
- #6 07A124EKA-X
- #7 25C1740B/GR-V-T
- #8 25A933AS/GR-V-T
- #9 MA3051/W-X

MAIN PWB  
(1/2)  
SMF-1601A-H2

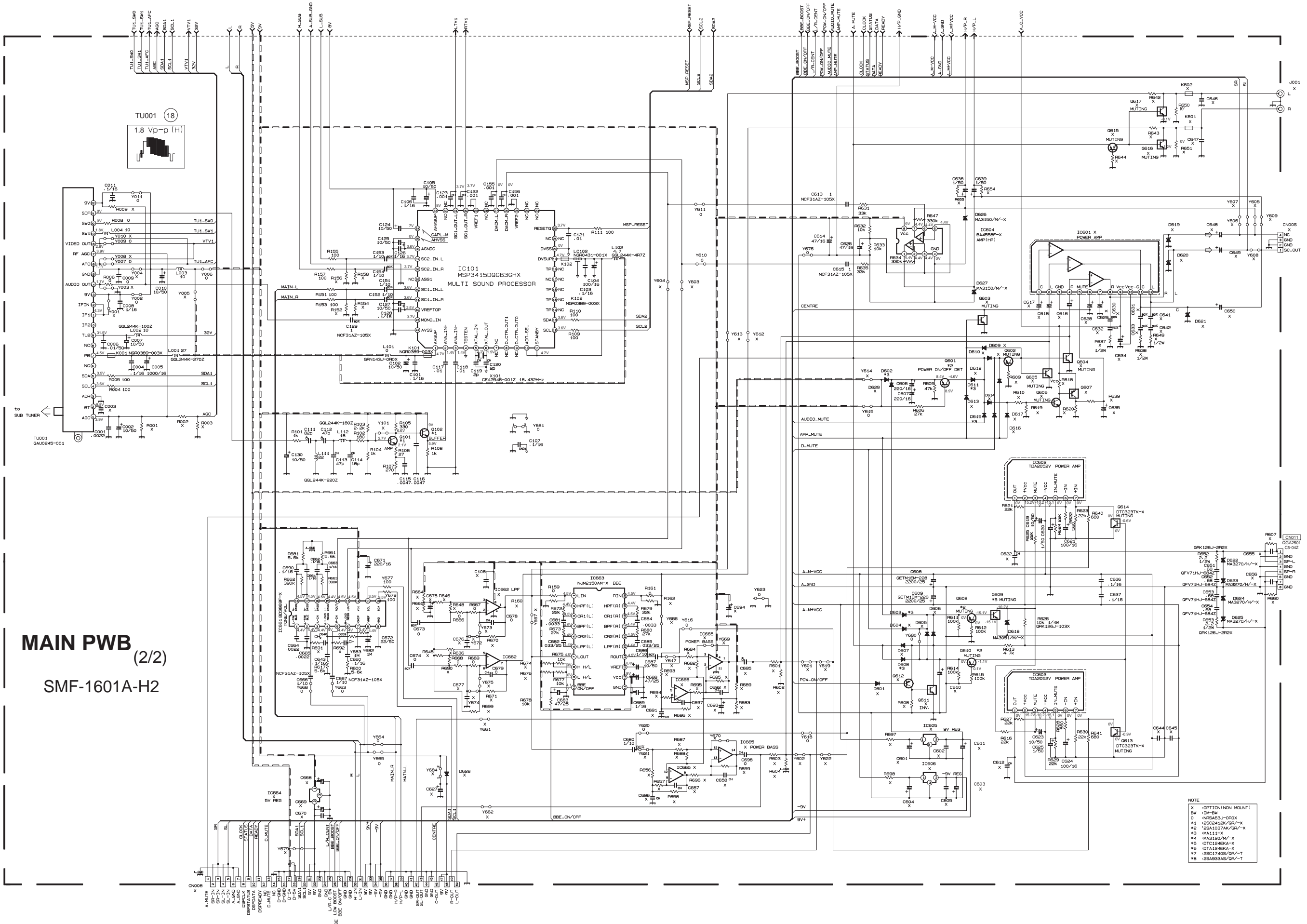

**MAIN PWB (2/2)**  
SMF-1601A-H2

NOTE  
 X (OPTION (NON MOUNT))  
 BW (TM-BW)  
 0 (NBS63J-CR0X)  
 \*1 (2SC2412K/GRV-X)  
 \*2 (2SA1037AK/GRV-X)  
 \*3 (MA1111-X)  
 \*4 (MA3120/M-X)  
 \*5 (DTC1246KA-X)  
 \*6 (DT14246KA-X)  
 \*7 (2SC1740S/GRV-T)  
 \*8 (2SA933AS/GRV-T)



100Hz PWB CIRCUIT DIAGRAM

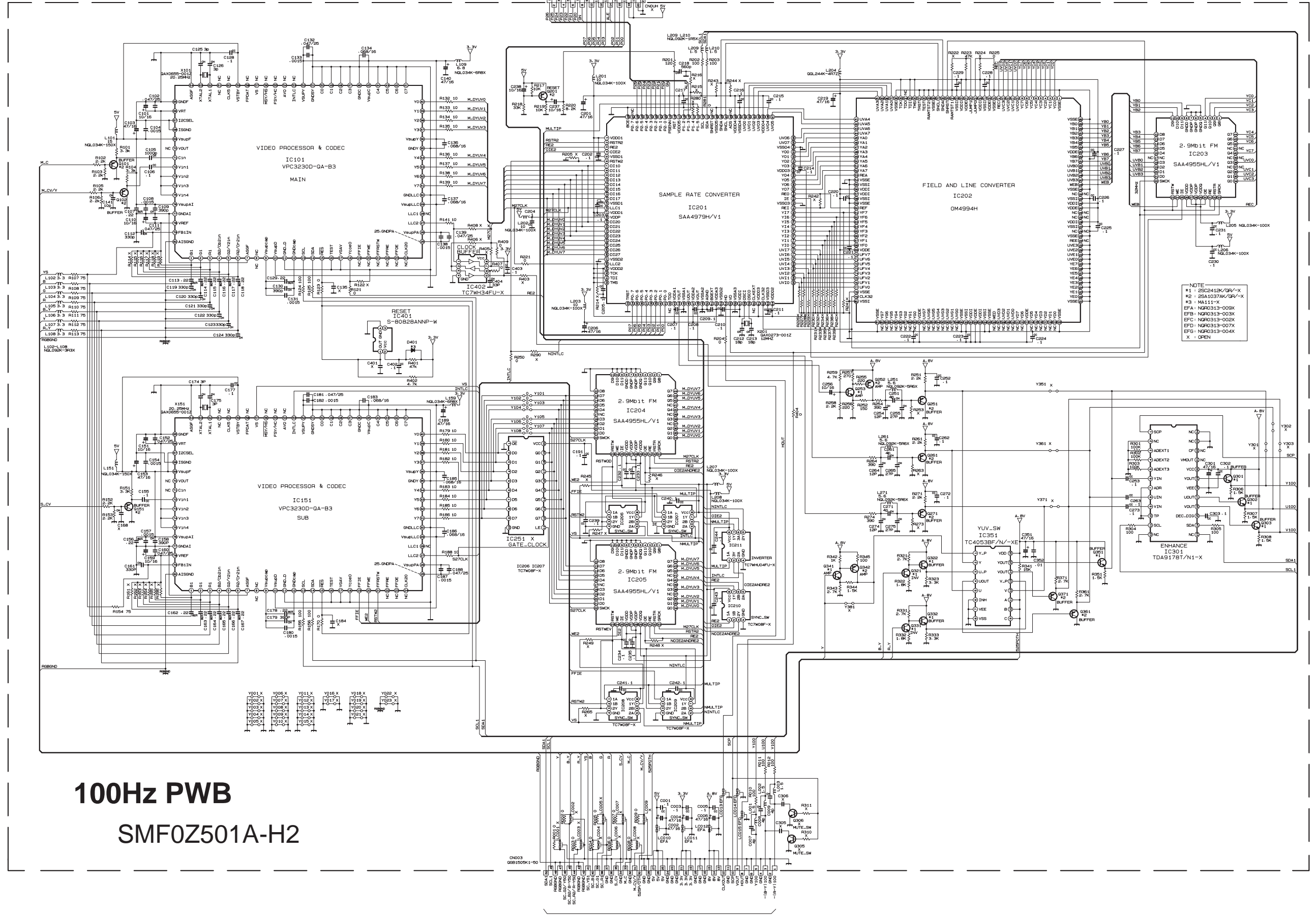

100Hz PWB SMF0Z501A-H2

MICON PWB CIRCUIT DIAGRAM

MICON PWB

SMF0M601A-H2 (HV-L29PRO/AU/EE)

SMF0M602A-H2 (HV-L29PRO/HK)

SMF0M603A-H2 (HV-L29PRO/-A)

NOTE

- \*1: 25C2712/YG/-X
- \*2: 25A1162/YG/-X
- \*3: MA111-X
- \*4: 25K1374-X
- \*5: MA3056/M/-X

X: OPEN  
O: CHIP BUS WIRE

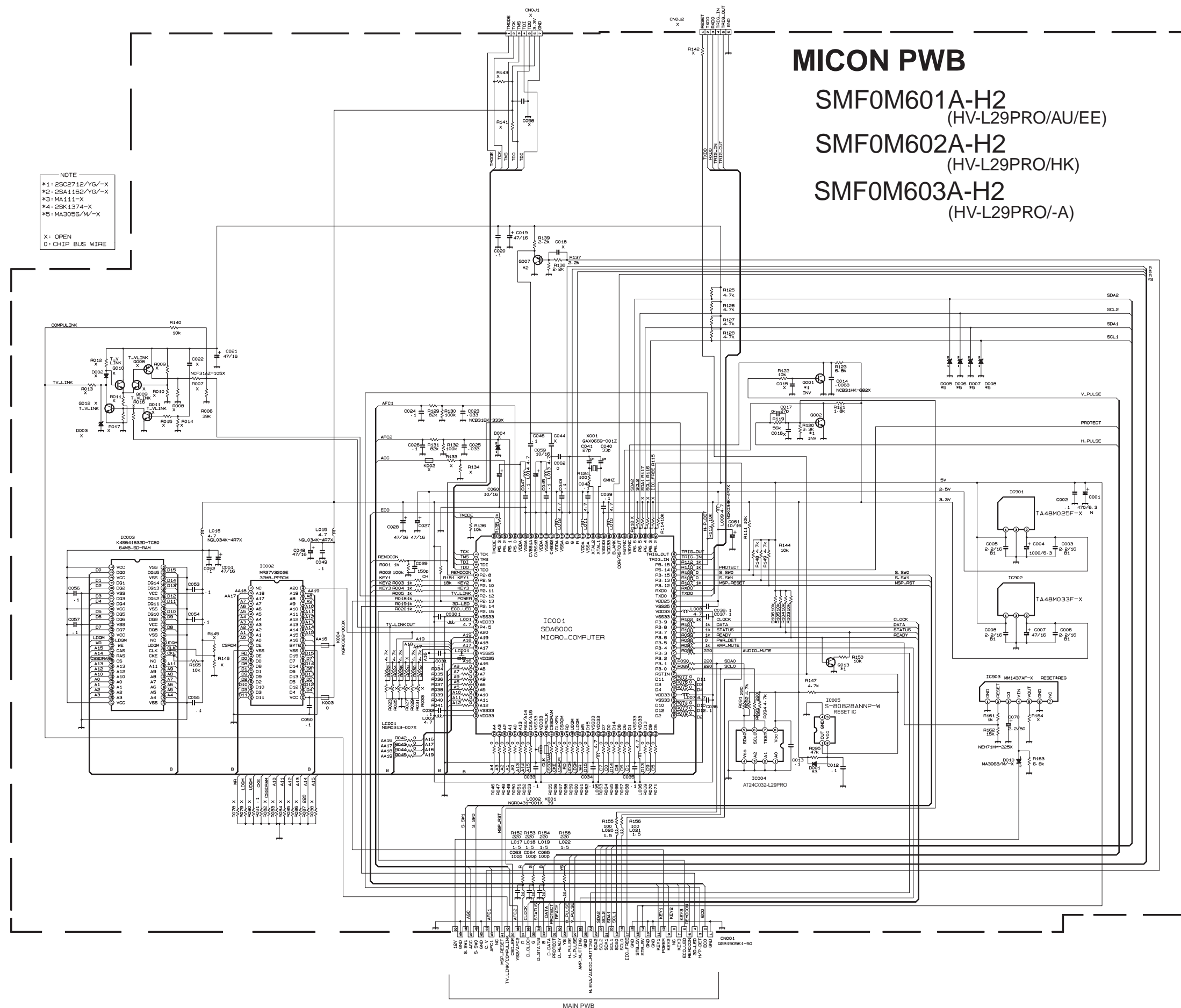

FRONT CONTROL PWB CIRCUIT DIAGRAM

# FRONT CONTROL PWB SMF-8501A-H2

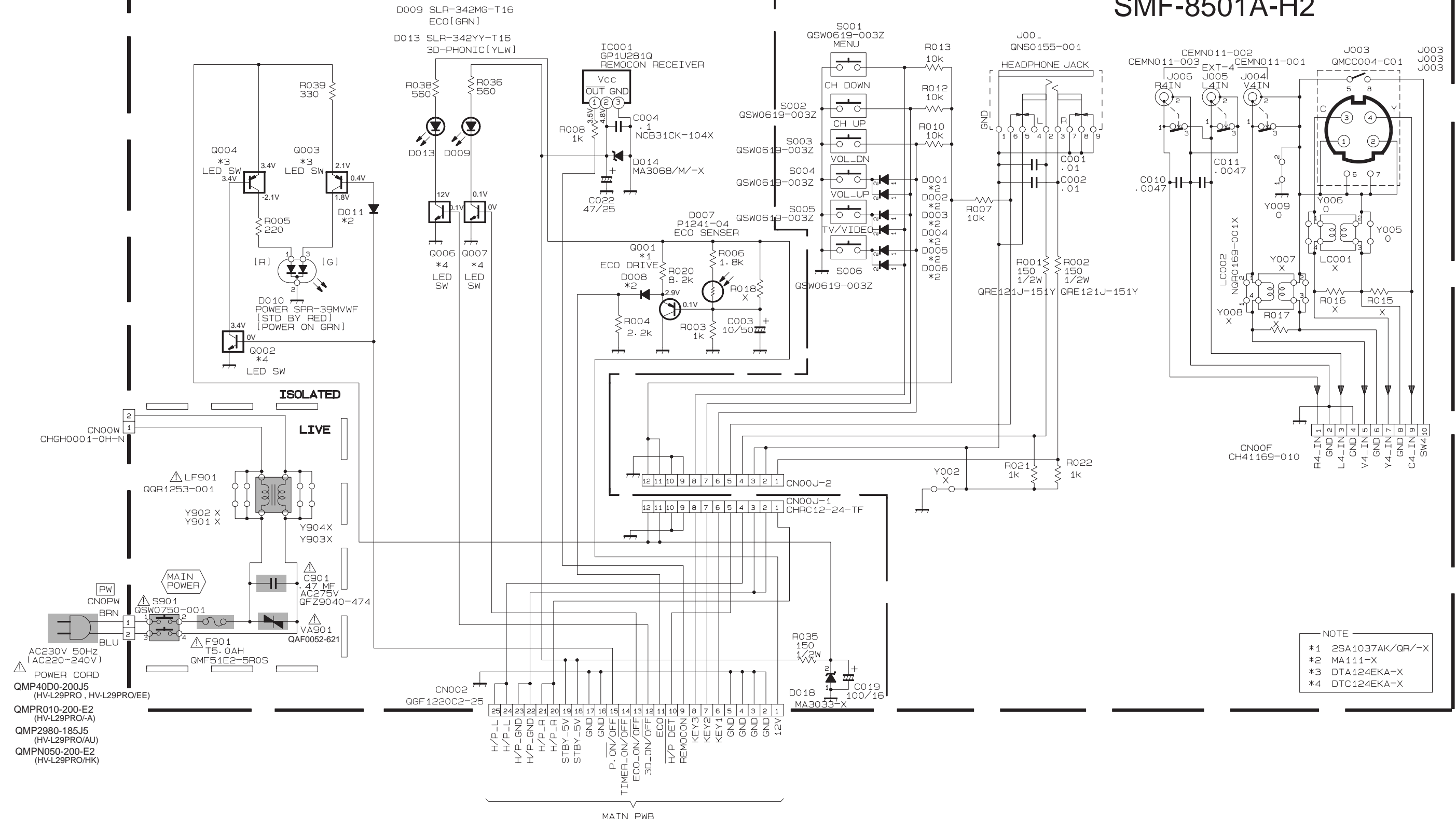



CRT SOCKET PWB CIRCUIT DIAGRAM

# CRT SOCKET PWB SMF-3502A-H2

NOTE  
 \*1: 2SC2412K/QR/-X  
 \*2: 2SA1037AK/QR/-X  
 \*3: MA1111-X  
 BW: BUS WIRE  
 X: NON-MOUNT (OPEN)

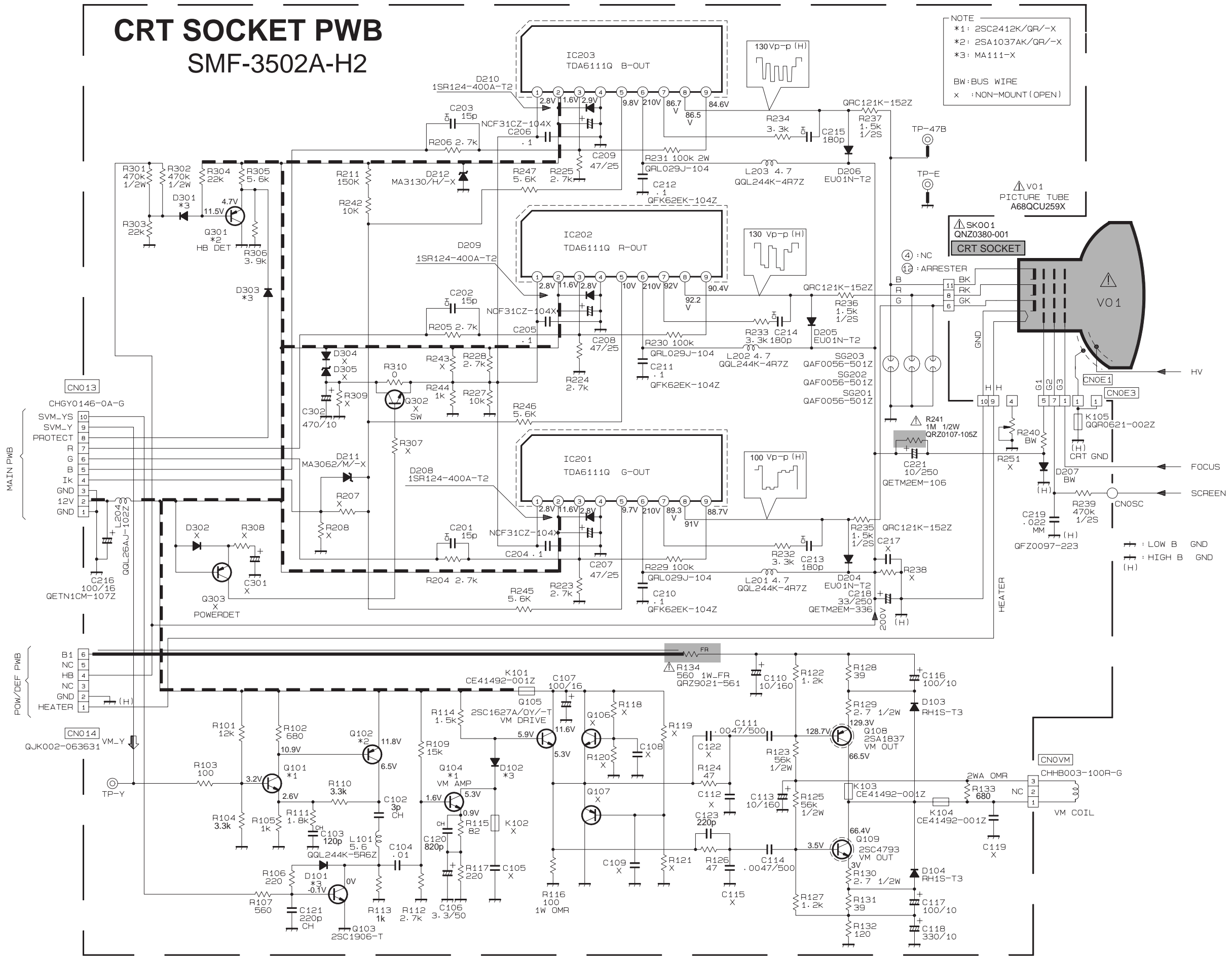

# AV SW PWB SMF0S501A-H2

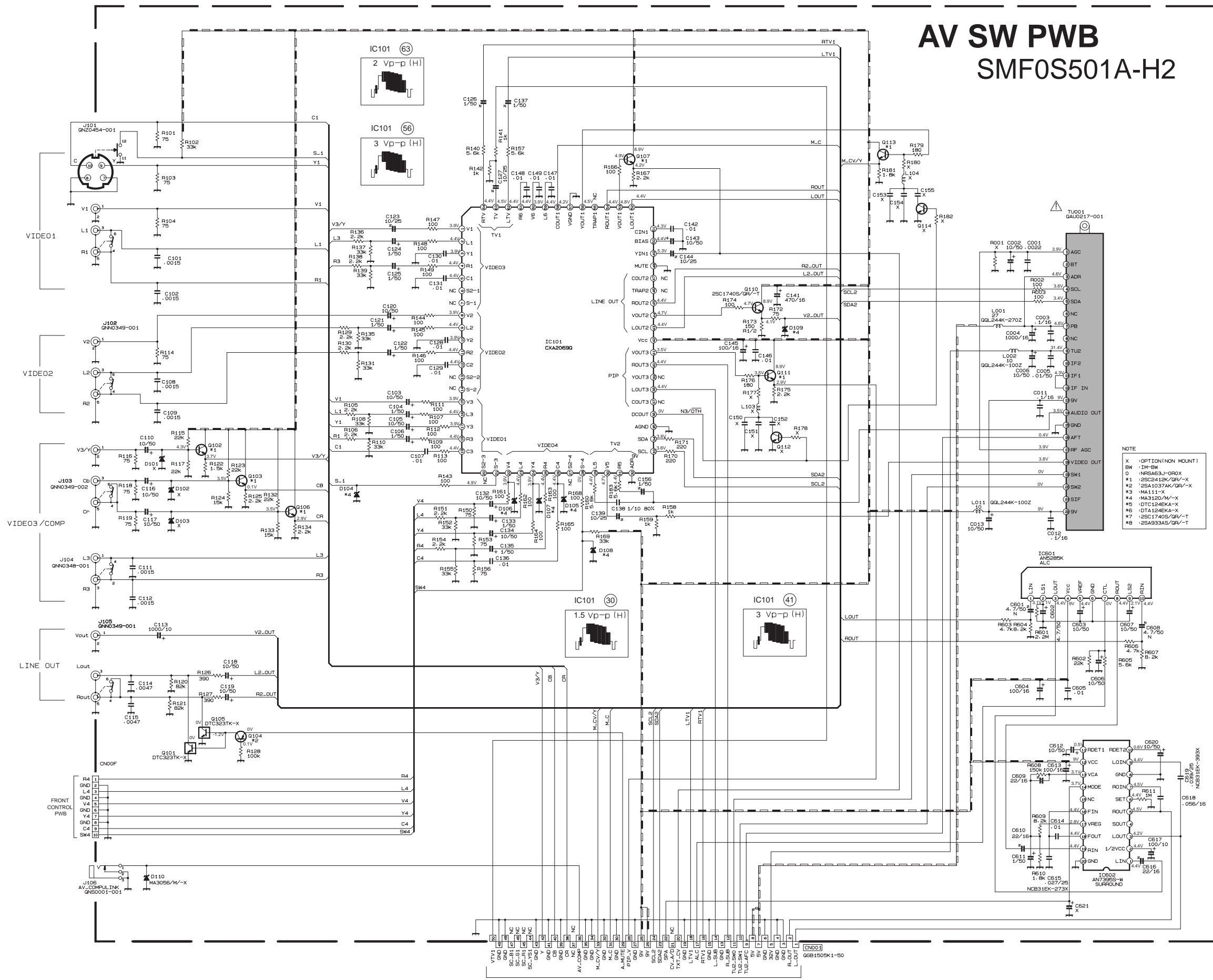

NOTE

- X : OPTION (NON MOUNT)
- BW : IM-BW
- 0 : NFA83J-OR0X
- #1 : 2SC242K/GR/-X
- #2 : 2SA1037AK/GR/-X
- #3 : MA1111-X
- #4 : MA3120/W/-X
- #5 : DT124EKA-X
- #6 : DT124EKA-X
- #7 : 2SC1740S/GR/-T
- #8 : 2SA933AS/GR/-T

SYNC SEP PWB CIRCUIT DIAGRAM

BLK PWB CIRCUIT DIAGRAM

# SYNC SEP PWB SMF0V501A-H2

# BLK PWB SMF0V502A-H2

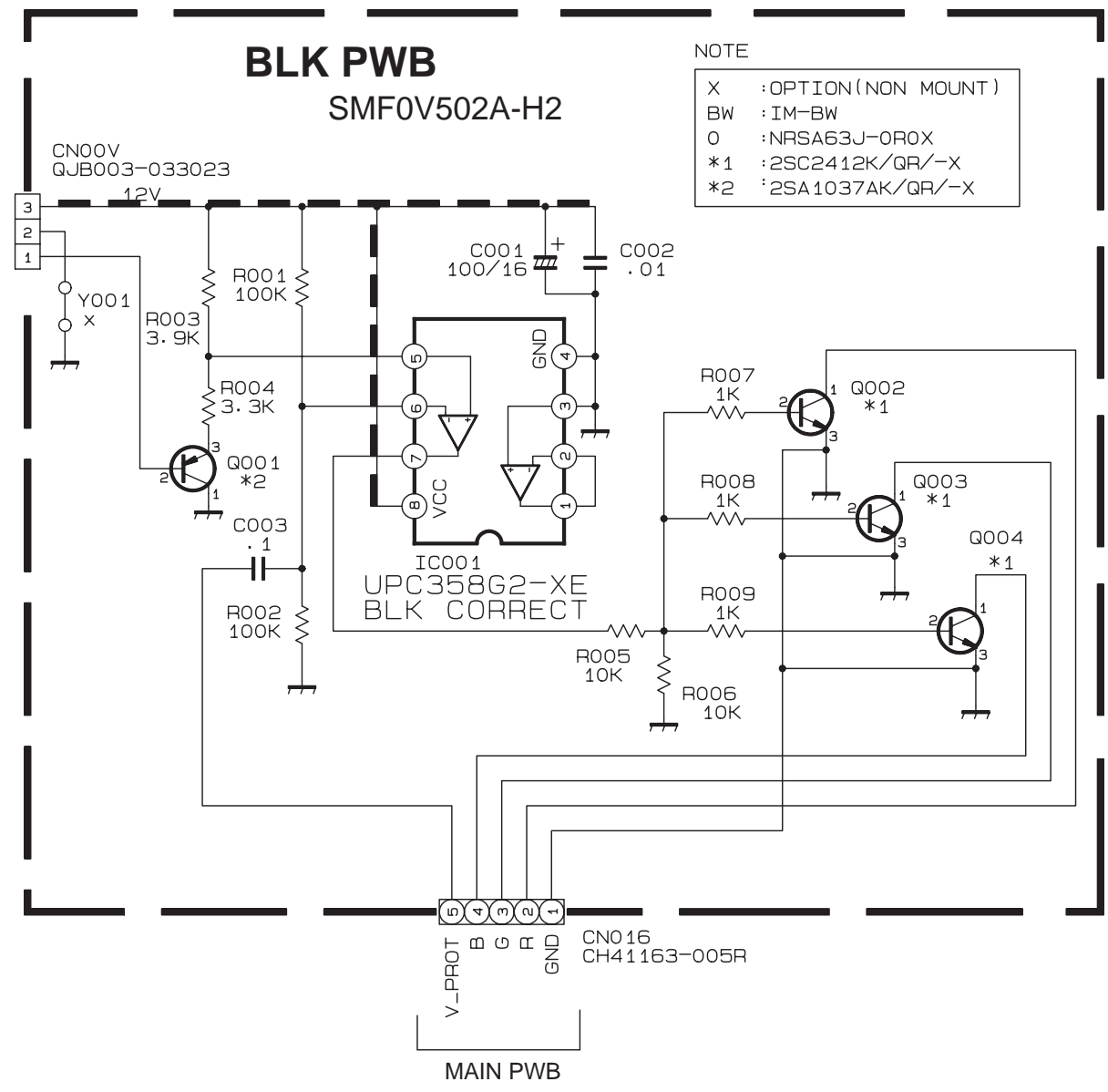
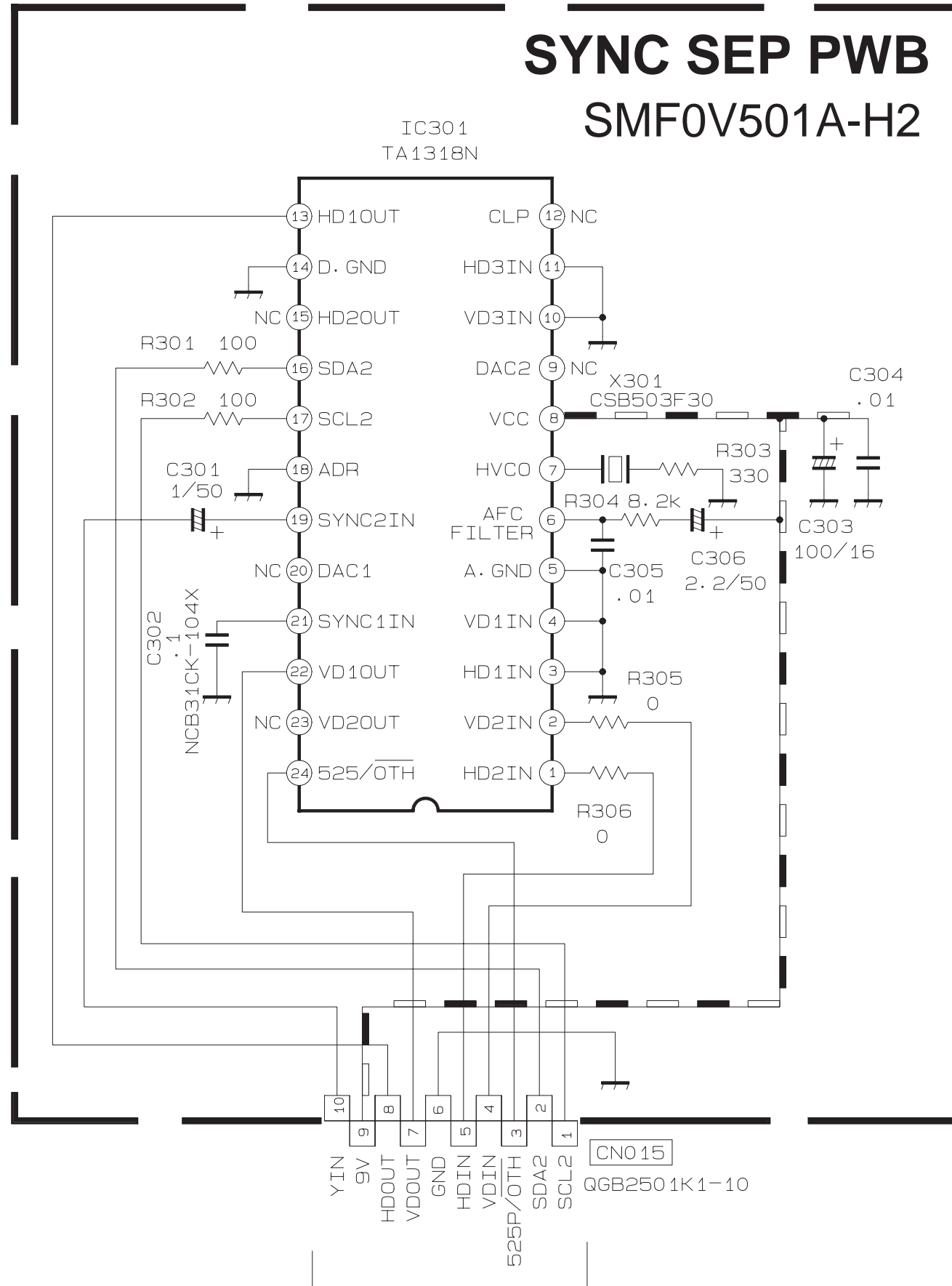

MAIN PWB

MAIN PWB

PATTERN DIAGRAMS MAIN PWB PATTERN

← FRONT

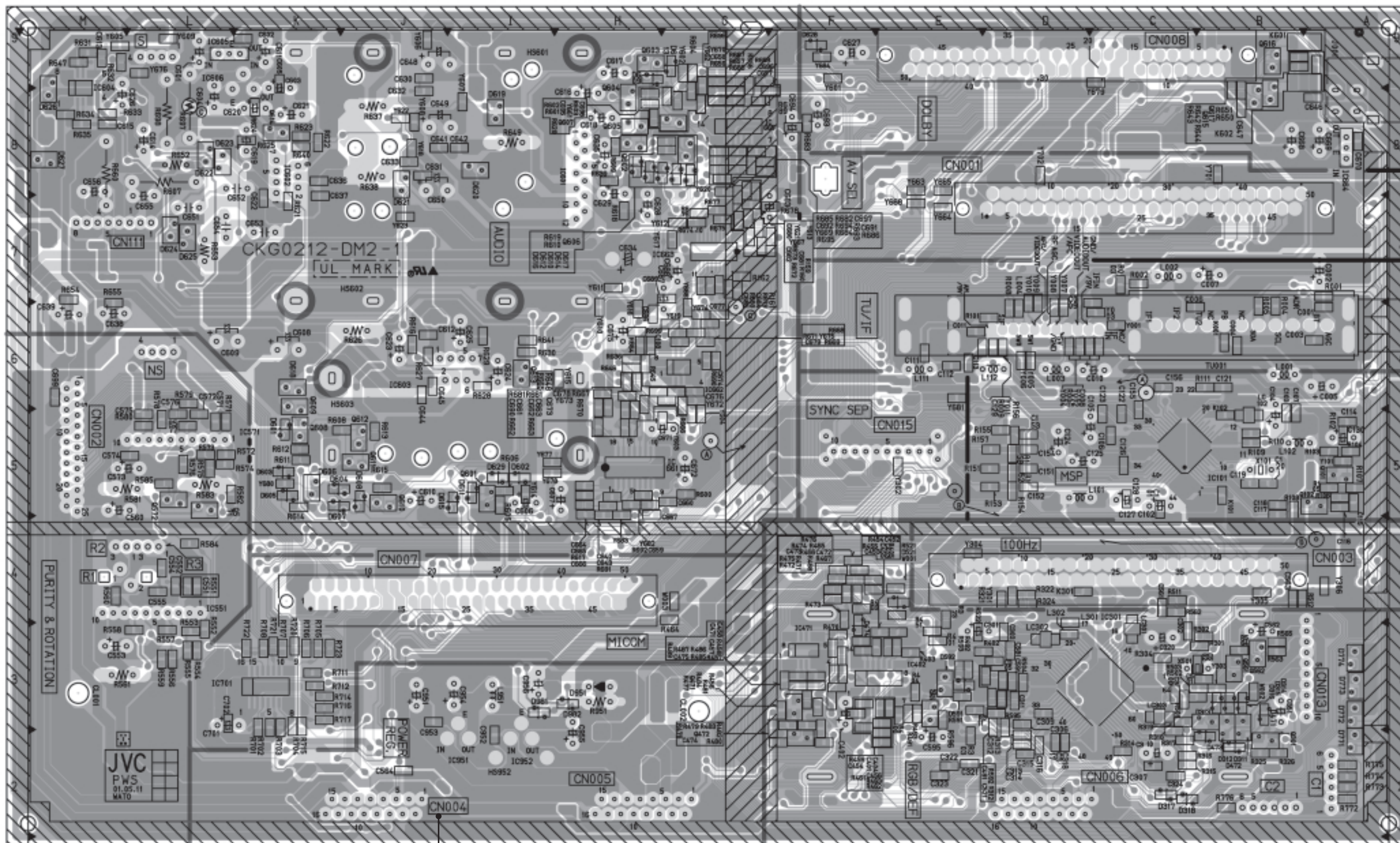

(77)

POWER & DEF PWB PATTERN

FRONT

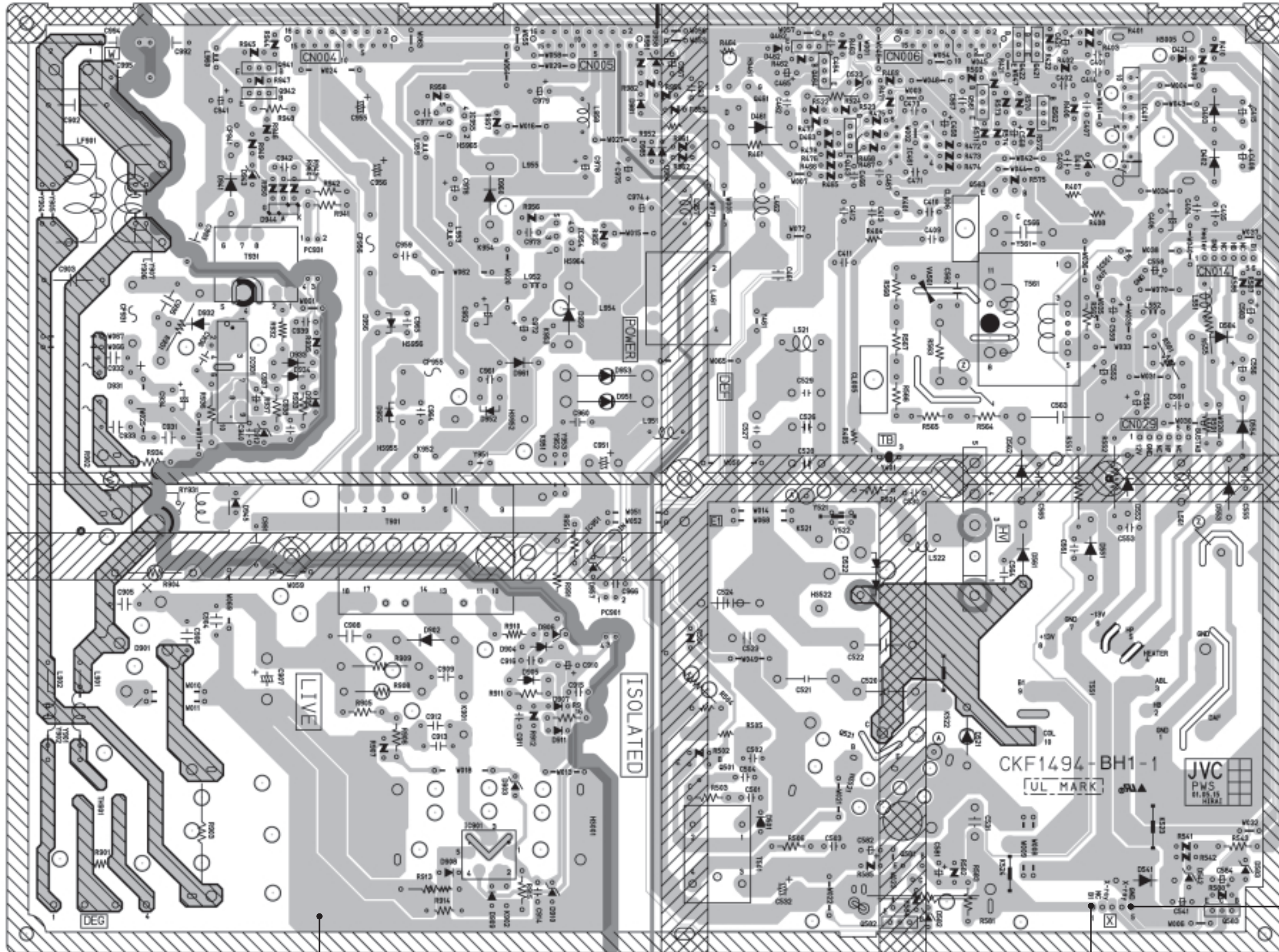

(T)

TP-E (T)

TP-91(B1)

100Hz PWB PATTERN (SOLDER SIDE)

100Hz PWB PATTERN (PARTS SIDE)

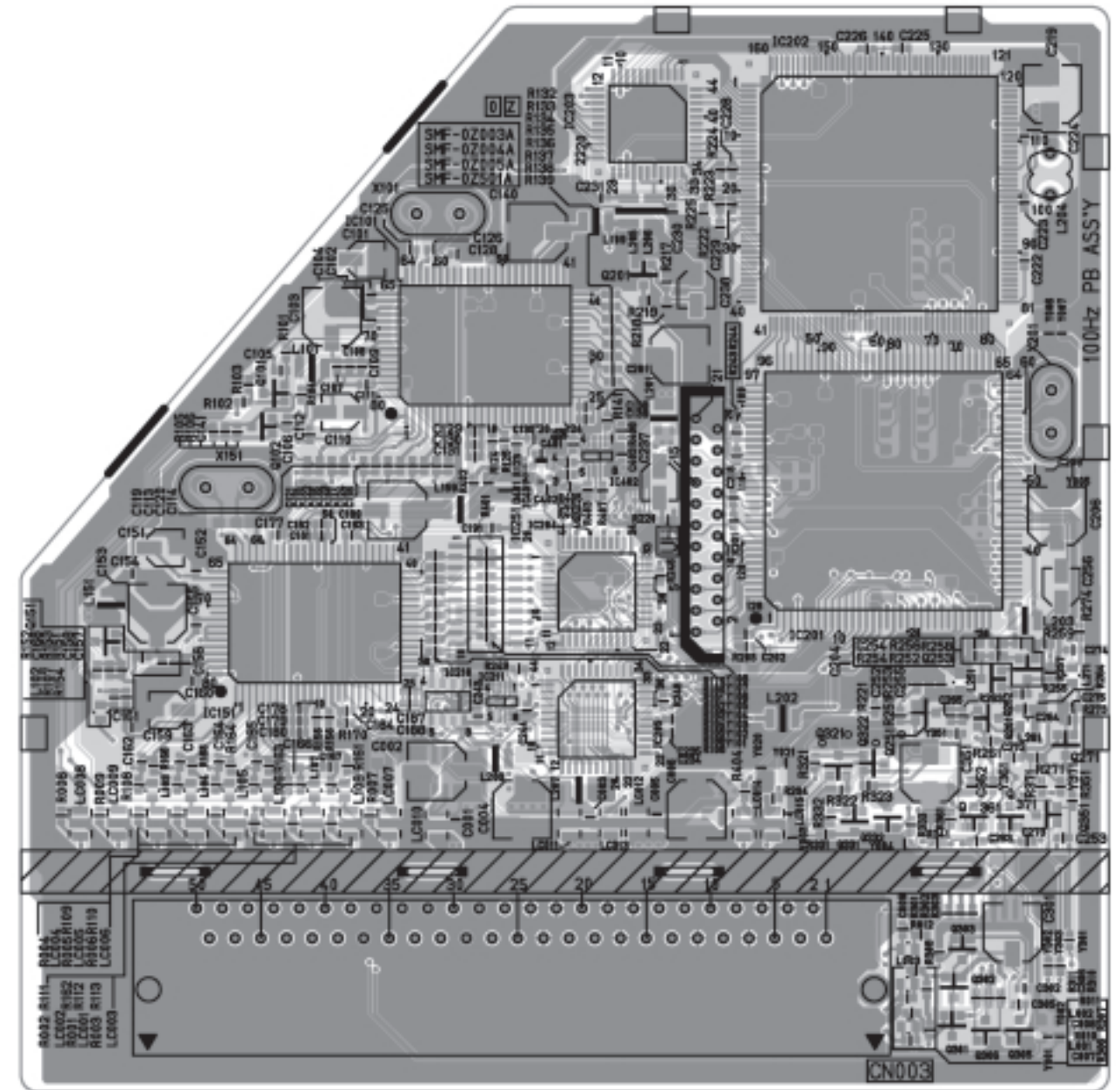
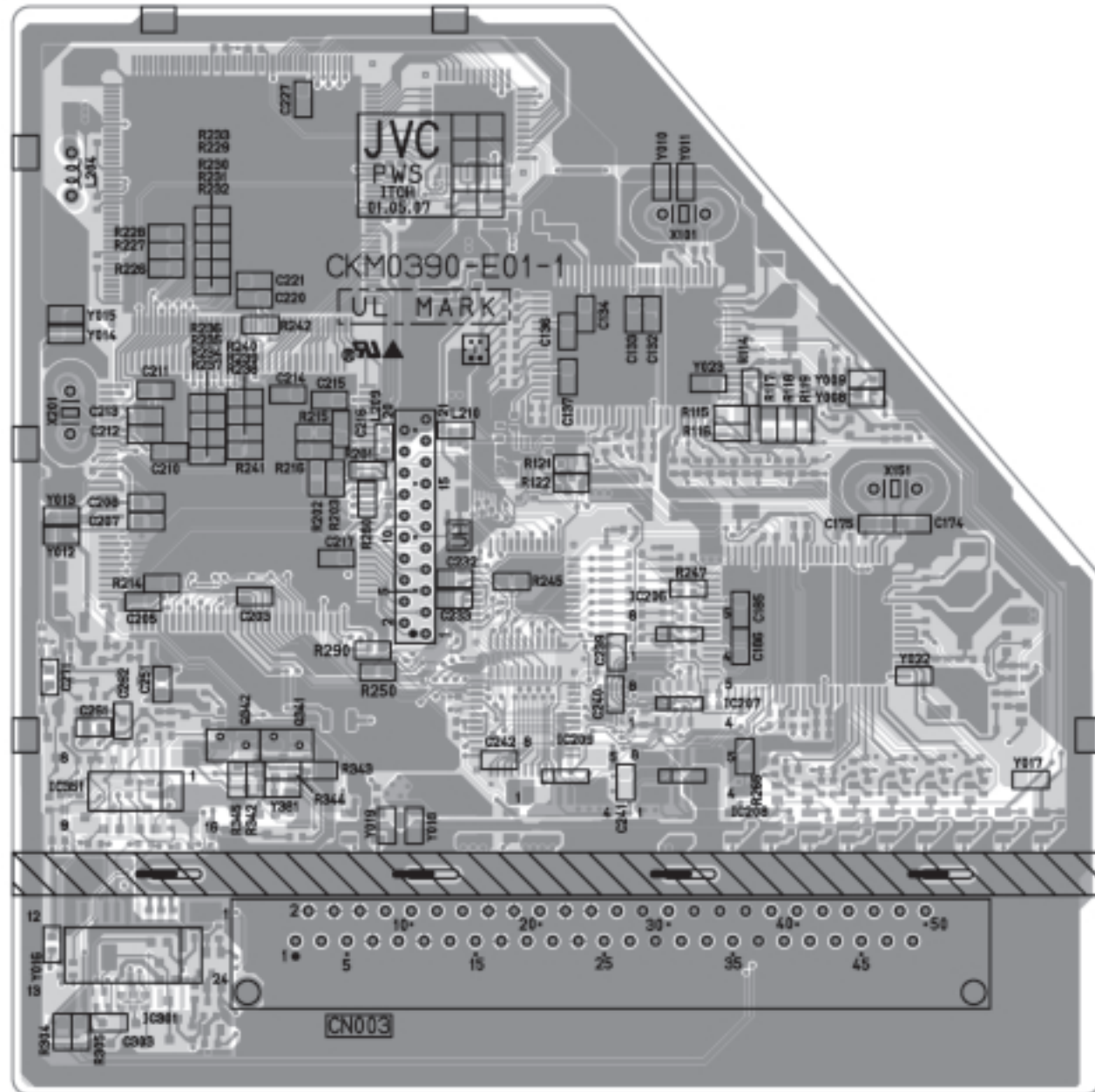



CRT SOCKET PWB PATTERN

AV SW PWB PATTERN



(7)

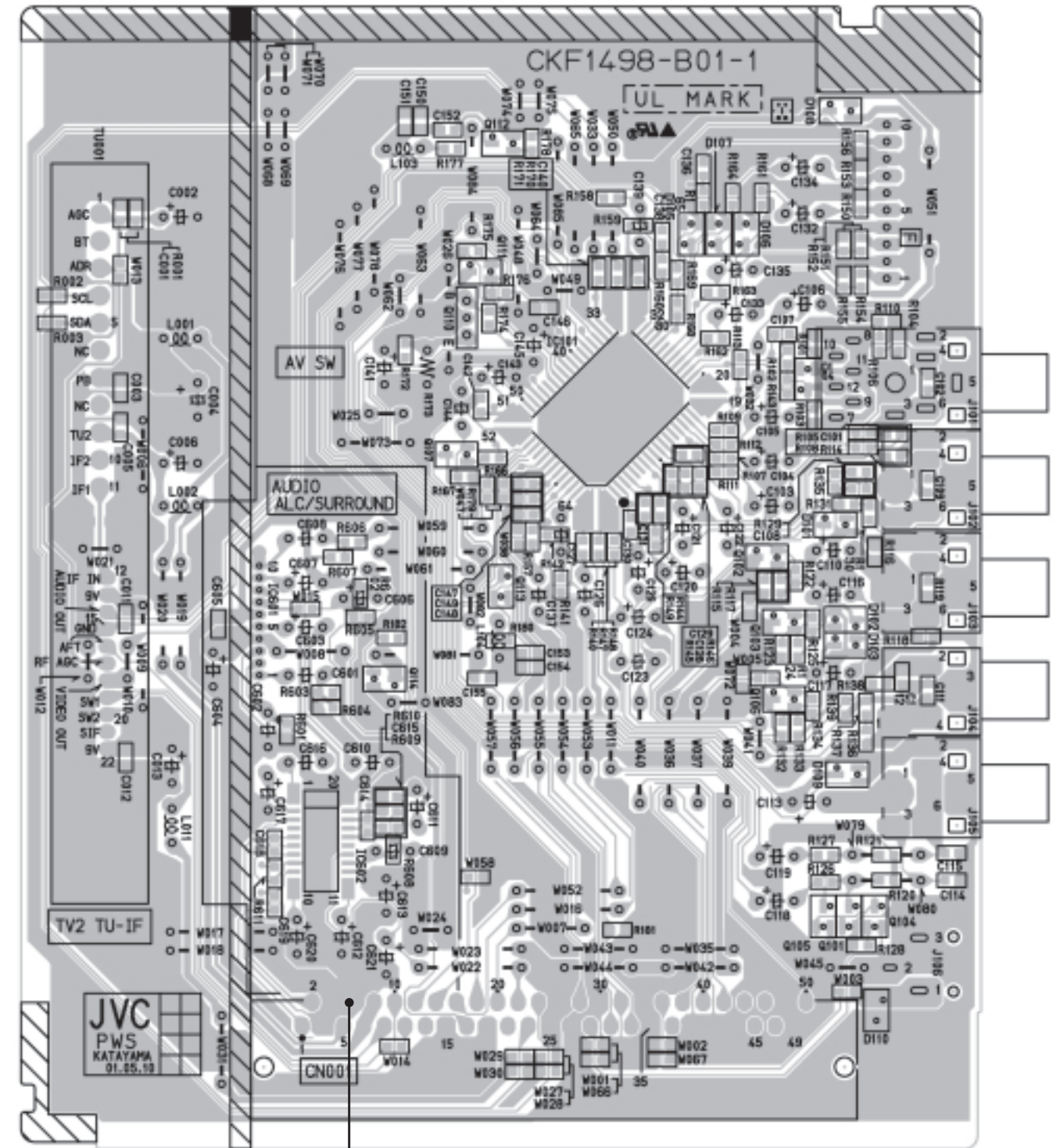
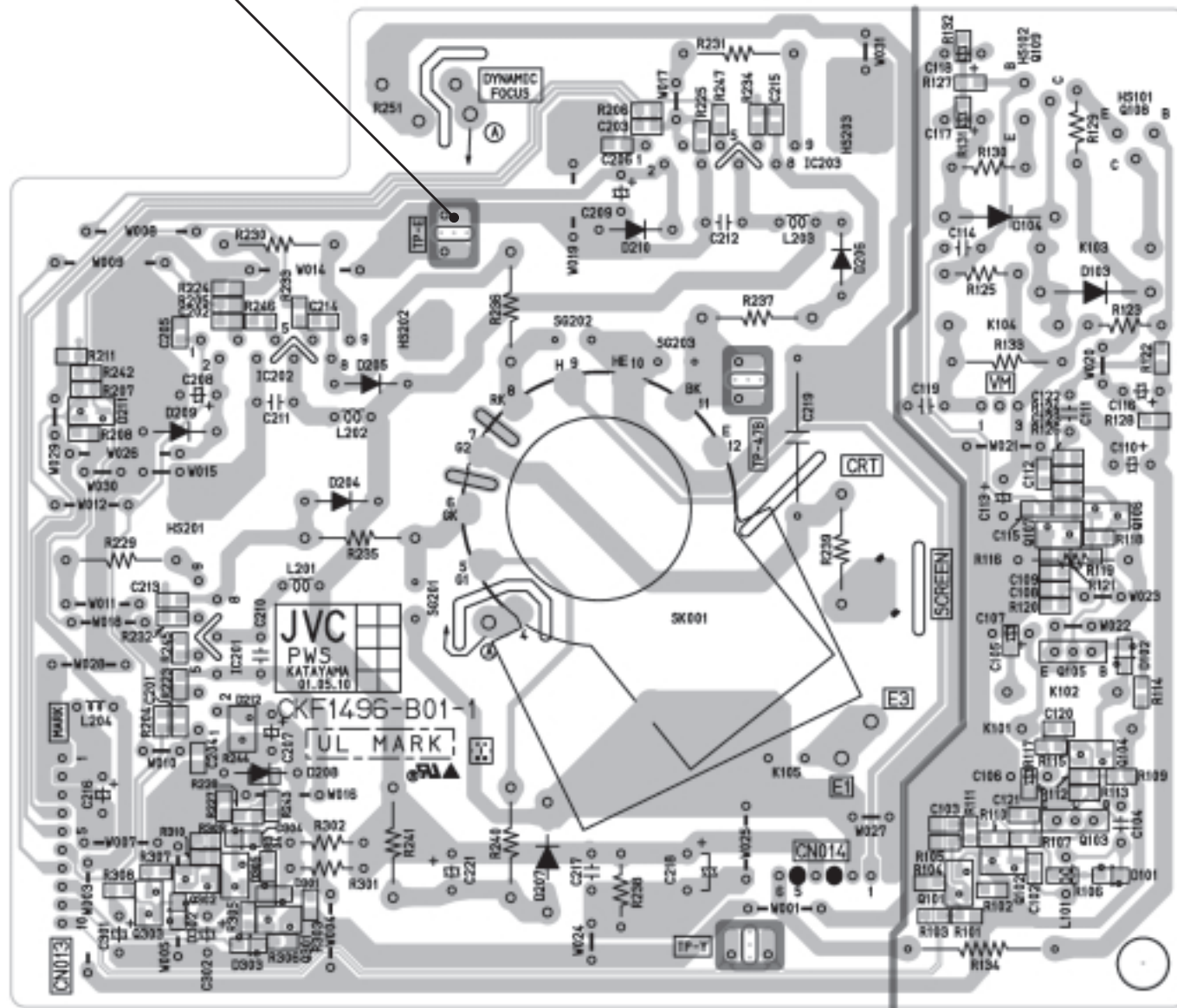

(7)



FRONT CONTROL PWB PATTERN

↑  
FRONT

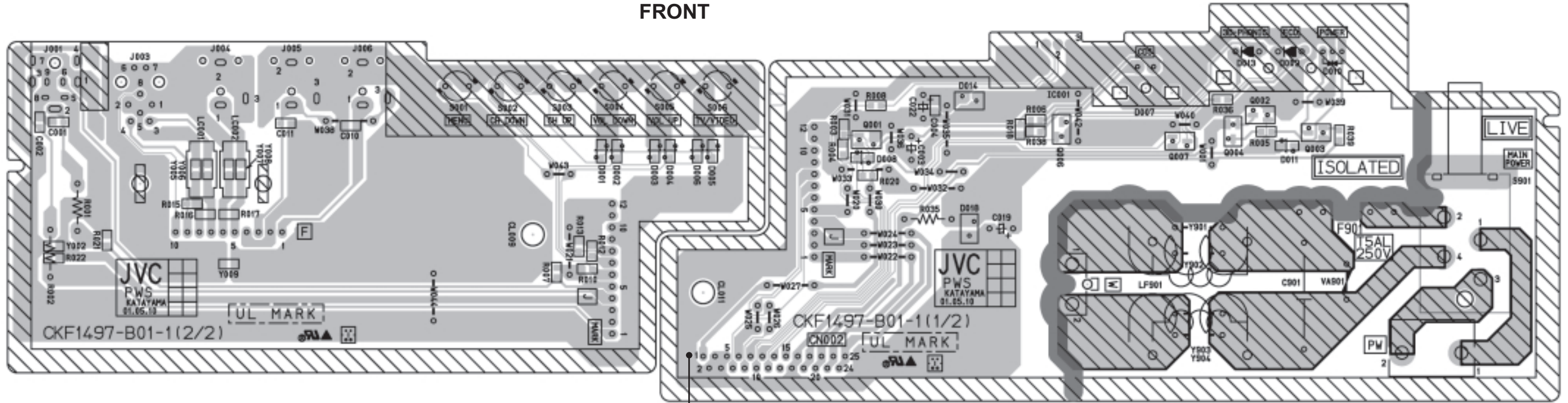

SYNC SEP PWB PATTERN

↑  
TOP

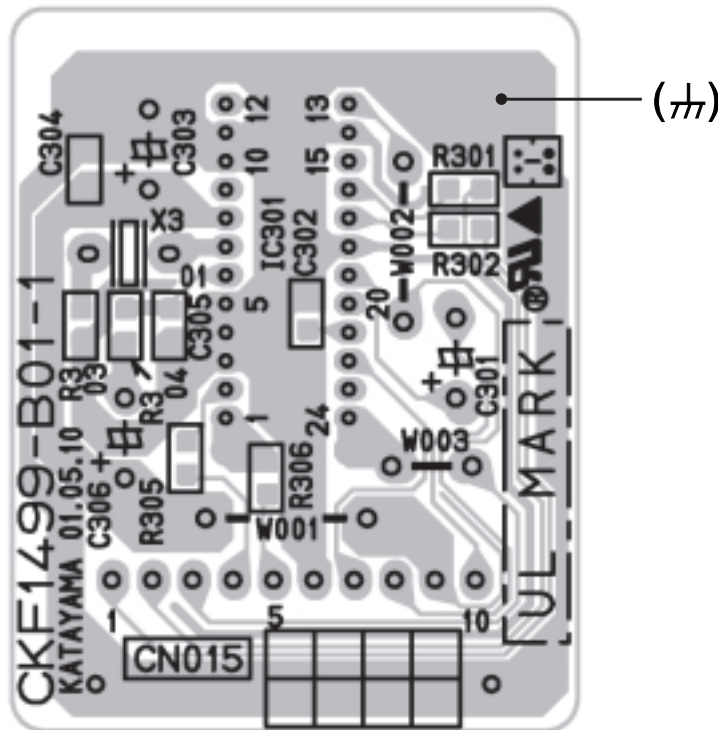

No.51828

BLK PWB PATTERN

↑  
TOP

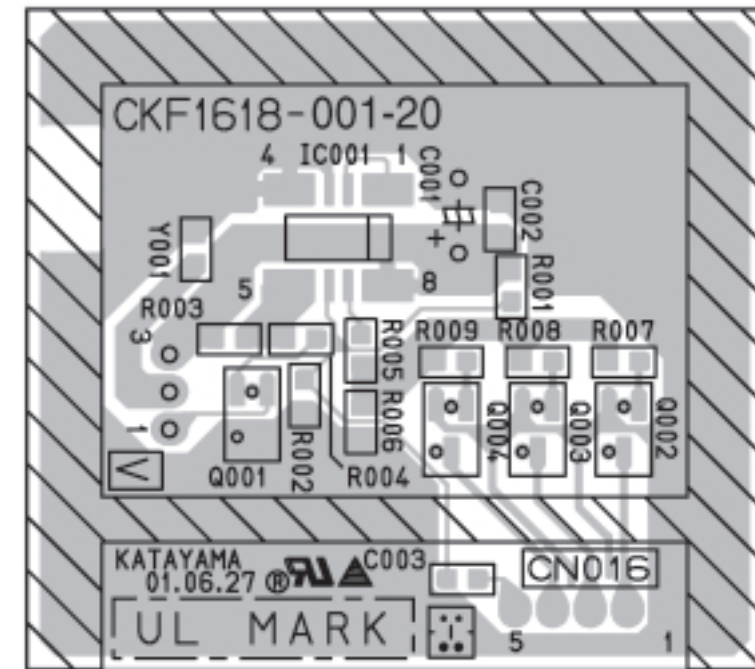

No.51828